

ARCHITECTURAL GRATES + DRAINS



120SCSTiIMTL

Shower Screen Support

Stormtech is the only linear drainage system available with full Greentag and Watermark certification across our complete product range.

Telephone 01483 346460 | Web slimlinedrain.co.uk





ARCHITECTURAL
GRATES + DRAINS



120SCSTiIMTL

Shower Screen Support

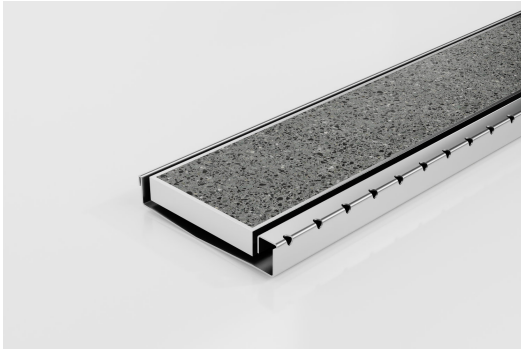

The Shower Screen Support Grate & Channel including 120mm wide Ti grate, with a 16mm screen support bar made from 316 Stainless Steel. Suits tiles up to 10mm thick

This multi-functional system provides support for both wall-hung shower screen and enclosed shower-screen units.

The dual-sided system drains on both sides of the shower screen and is suitable for use as the sole bathroom drain. Wall-to-wall installation allows simple dual fall across the bathroom for easy tiling. Available in Made-to-length drainage units or is fully customisable in width, length and outlet position.

Made from 316 Stainless Steel, the 120SCS is designed for flexibility, and ease of installation and exceeds all Australian Standards, is WaterMark certified and is exclusive to Stormtech protected by Patent Number: 2021904197.

Code 120SCSTiIMTL

Range Shower Screen Support

Grate Style Ti

Category Made-to-Length

Channel Material Stainless Steel

Steel Grade 316

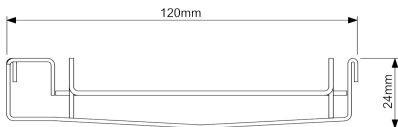

Grates longer than 1500mm supplied in sections. Tile Inserts longer than 1200mm supplied in sections. Channels over 3000mm supplied in sections with joiner. +/-2mm tolerance on dimensions.

SPECIFICATIONS + DIMENSIONS

Channel Width	120mm
Channel Depth	24mm
Length(s)	As Required
Outlet Size	DN80, DN100

STORMTECH COLOUR FINISHES

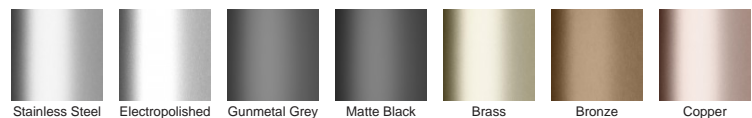

Electroplate finishes subject to natural variation with time and local environment. Factors such as pools/surf beaches may require electropolishing. Contact us for suitability.

PRODUCT APPLICATIONS

- Bathroom Drainage
- Aged / Health Care Drainage
- Commercial Drainage
- Hospitality Drainage
- Shower Drainage
- Multi-Residential Drainage
- Special Needs Drainage



Copyright © Stormtech Pty Ltd. Patent 733361. Drawings not to scale, please use dimensions shown. Downloaded 09/02/2024 (please check for updates)

Visit slimlinedrain.co.uk
for tools + inspiration.

Phone 01483 346460

Email technical@slimlinedrain.co.uk

120SCS Bathroom

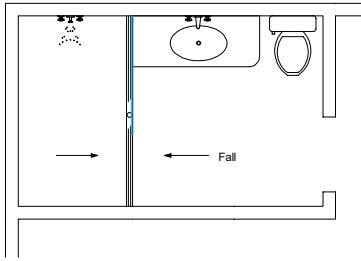

NOTE, refer to AS3500 for specific outlet pipe sizes related to your specific installation.

NOTE, refer to AS3740 for waterproofing requirements related to your specific installation.

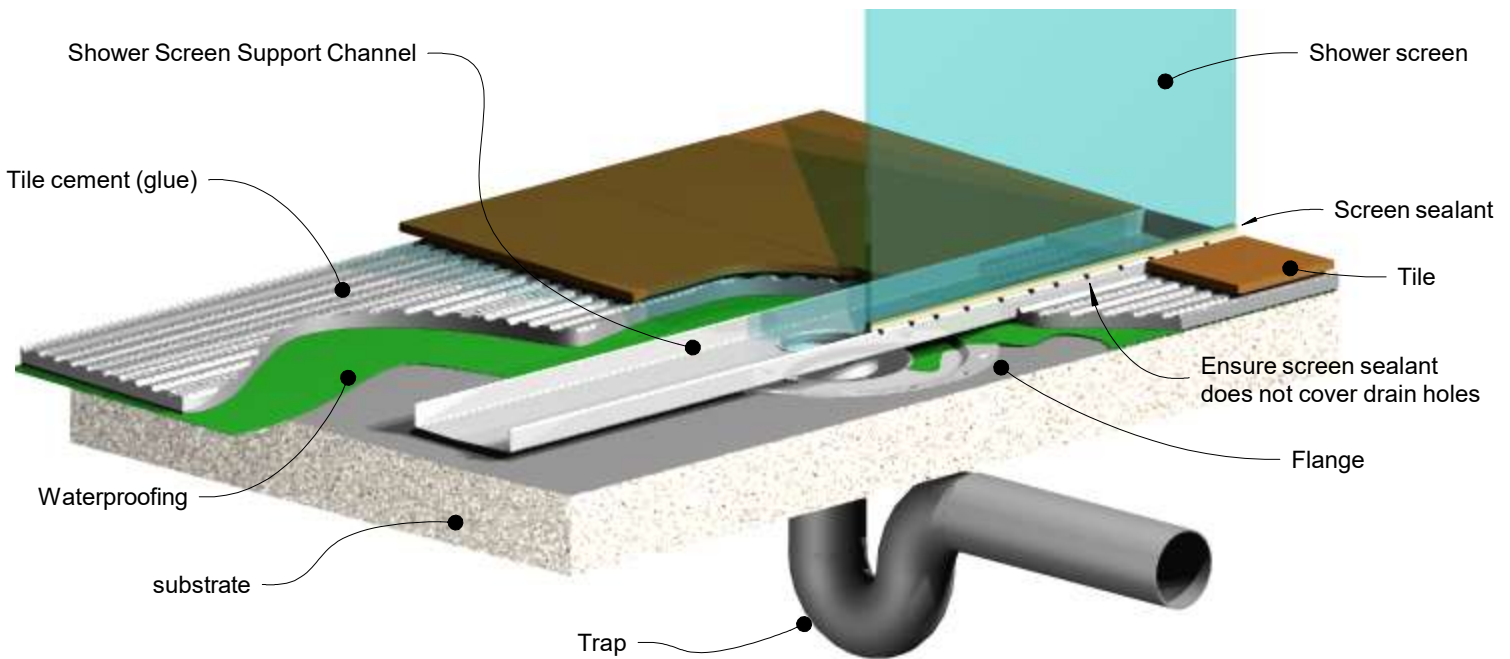
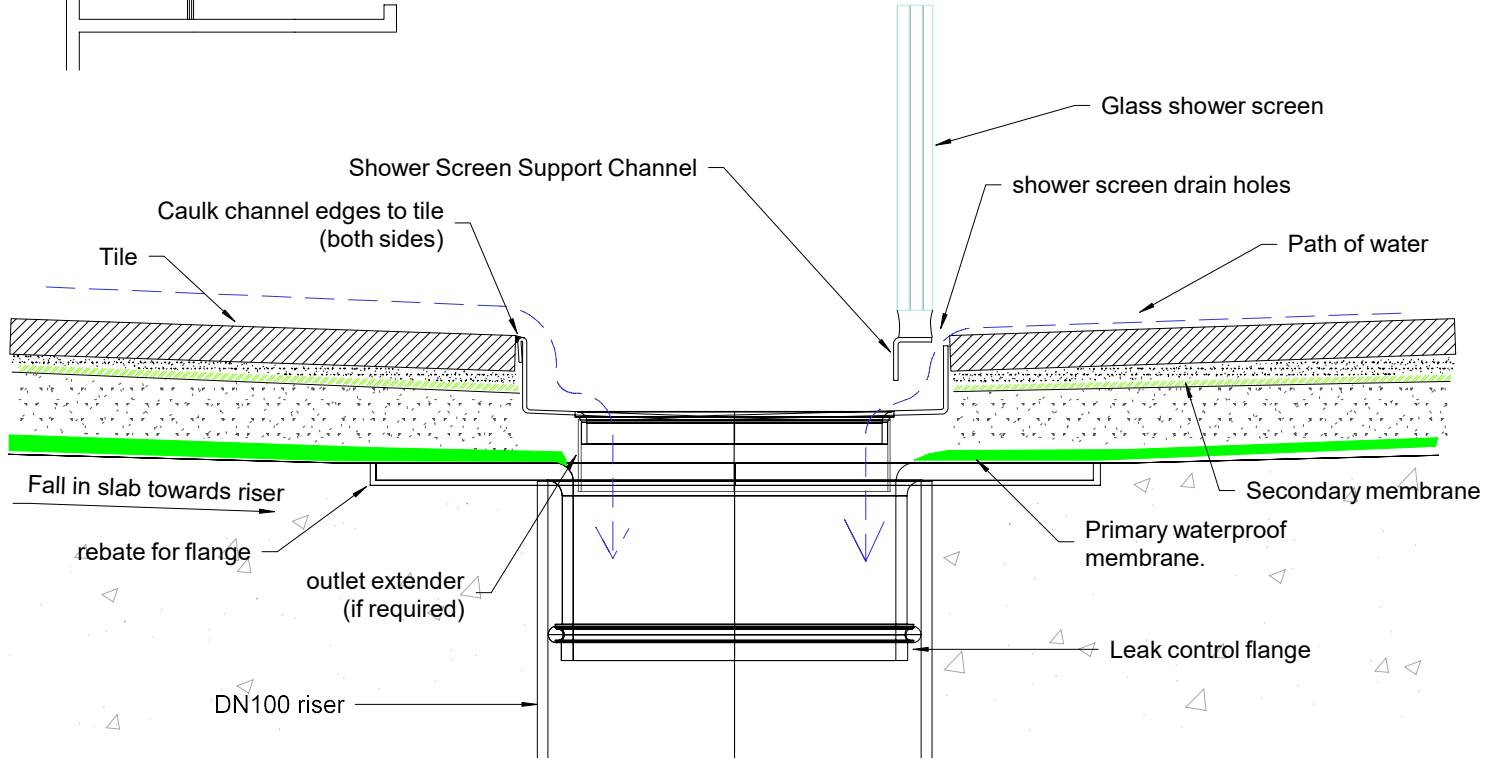

NOTE, this method requires the channel system to be ABOVE and SEPARATE from the WATERPROOFING.

NOTE, No grates or tile inserts are shown for clarity.



Order and Quote Form

Made-to-Length Shower Screen Support Grate + Channel

Select Grate Style

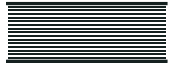

AR Architectural
2mm wire
2.5mm gap



TR Standard
3mm wire
5mm gap



Ti Tile Insert



MND Marc Newson



PS Punched Slot



PPS Punched Perpendicular Slot



PAS Punched Angle Slot

Grate + Channel Profiles

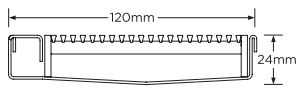

AR

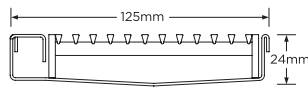

TR

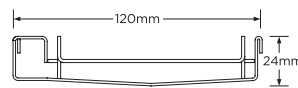

Ti

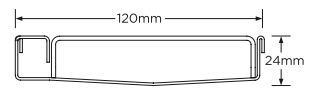

MND, PS, PPS, PAS

Shower Screen Position + Dimensions Choose Right OR Left Screen Position to Suit Requirements

1. RIGHT POSITION SHOWER SCREEN

Required Outlet Size

76mm* 89mm

* Only suitable with DN80 riser

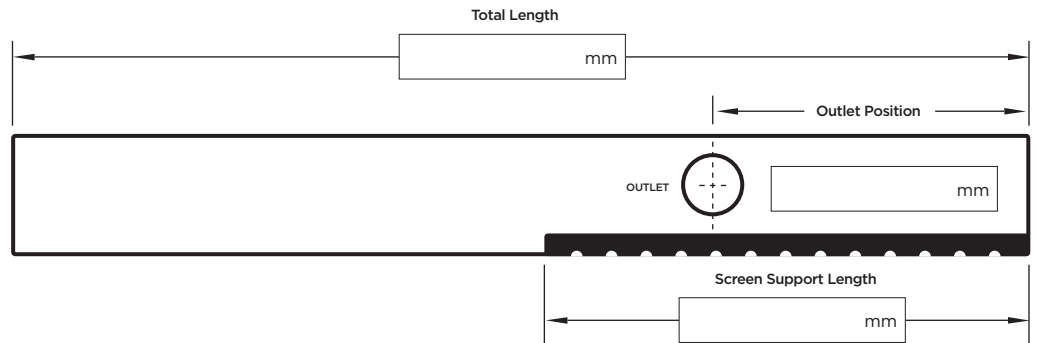

2. LEFT POSITION SHOWER SCREEN

Required Outlet Size

76mm* 89mm

* Only suitable with DN80 riser

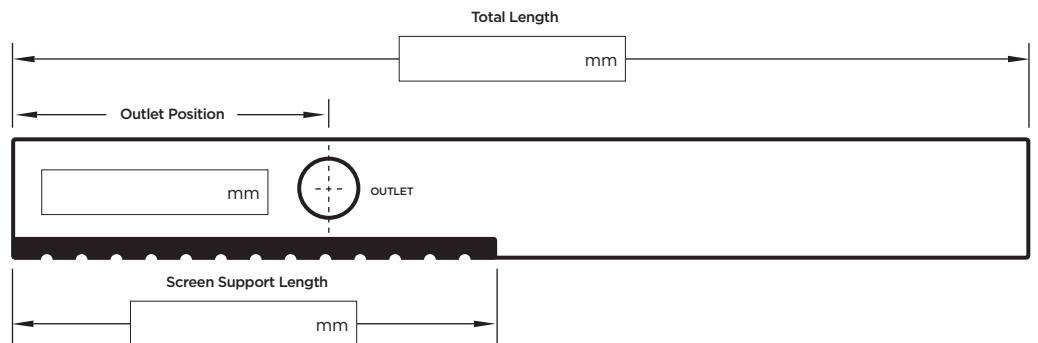

Please Note

See AS3500 standard & local regulator for specific outlet and drainage requirements. Stainless Steel Grade is 316 unless specified. Minimum charge of 1000mm. Grates longer than 1500mm and Tile Inserts longer than 1200mm are supplied in multiple sections. Channels 3000mm maximum in one piece, channels over 3000mm are supplied in multiple sections with joiner. +/- 2mm tolerance on dimensions.

Full Name

Company Name

Telephone

Email Address

Order Number

Stormtech Quote Number

Signature



Order and Quote Form

Made-to-Length

Dual-Sided Shower Screen Support

Select Grate Style



AR Architectural
2mm wire
2.5mm gap

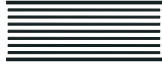

TR Standard
3mm wire
5mm gap



Ti Tile Insert
Tile depth
up to 10mm



MND Marc Newson



PS Punched Slot



PPS Punched Perpendicular Slot



PAS Punched Angle Slot

Grate + Channel Profiles

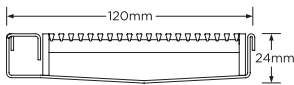

AR

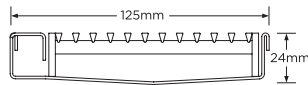

TR

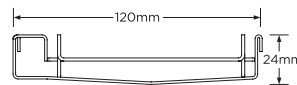

Ti

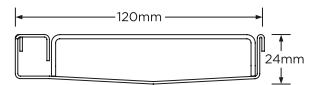

MND, PS, PPS, PAS

Dual Sided Shower Screen Dimensions

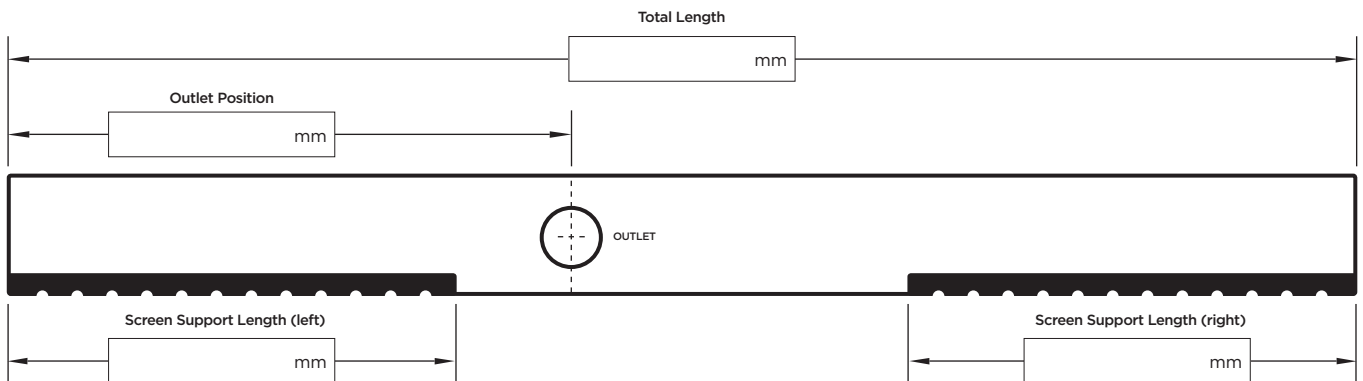
 Please include all measurements.

Required Outlet Size

76mm* 89mm

* Only suitable with DN80 riser

Please Note

See AS3500 standard & local regulator for specific outlet and drainage requirements. Stainless Steel Grade is 316 unless specified. Minimum charge of 1000mm. Grates longer than 1500mm and Tile Inserts longer than 1200mm are supplied in multiple sections. Channels 3000mm maximum in one piece, channels over 3000mm are supplied in multiple sections with joiner. +/- 2mm tolerance on dimensions.

Full Name

Company Name

Telephone

Email Address

Order Number

Stormtech Quote Number

Signature

Phone 01483 346 460

Email technical@slimlinedrain.co.uk

slimlinedrain.co.uk

120SCSTiiMTL Left Hand Side Support

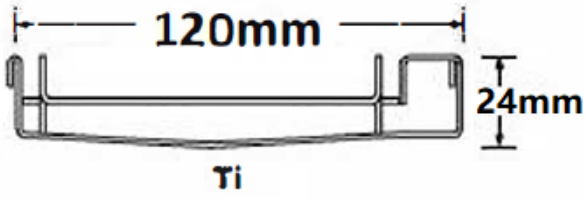

Full Name

Company Name

Project Name / Project Stage



Label _____

Required Outlet Size

 76mm* 89mm

* Only suitable with DN80 riser

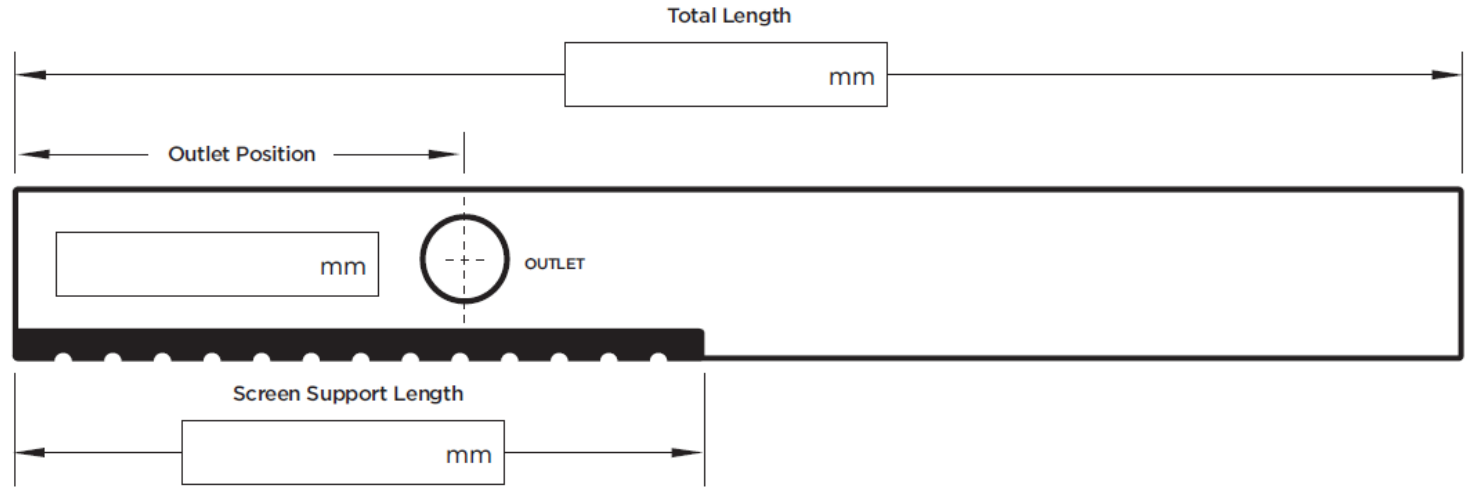

Label _____

Required Outlet Size

 76mm* 89mm

* Only suitable with DN80 riser

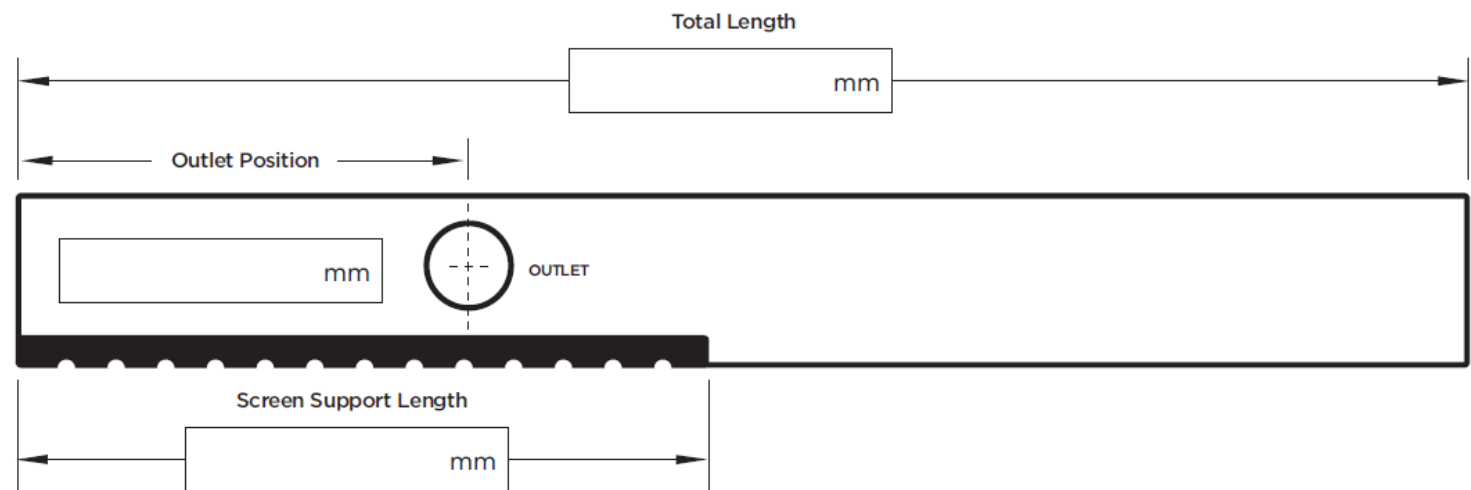

Label _____

Required Outlet Size

 76mm* 89mm

* Only suitable with DN80 riser

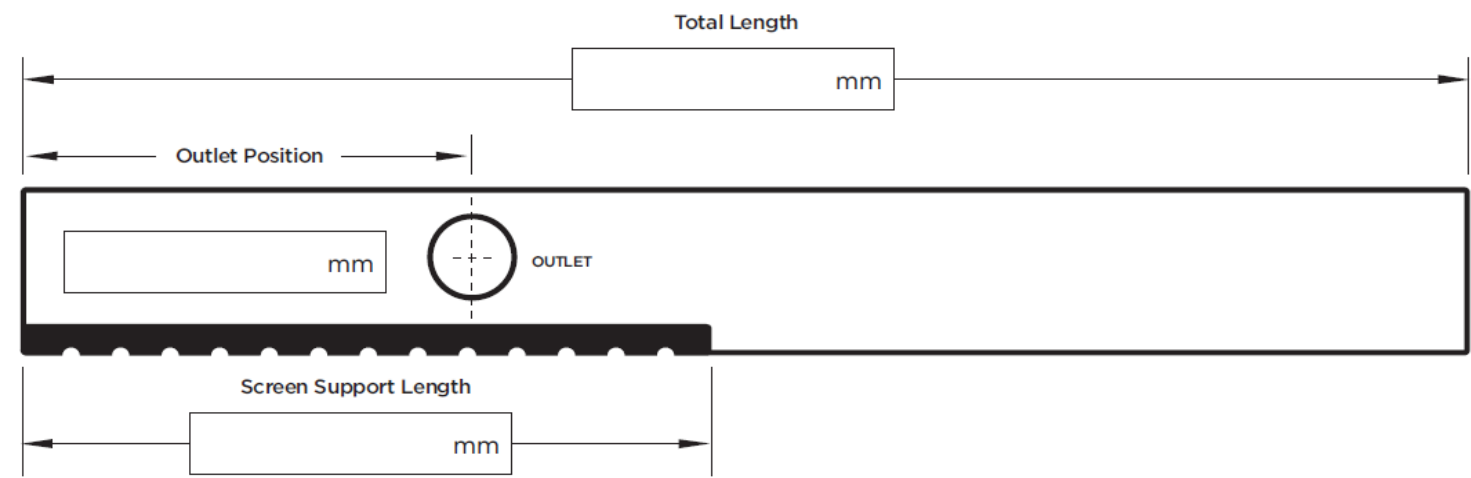

Label _____

Required Outlet Size

 76mm* 89mm

* Only suitable with DN80 riser

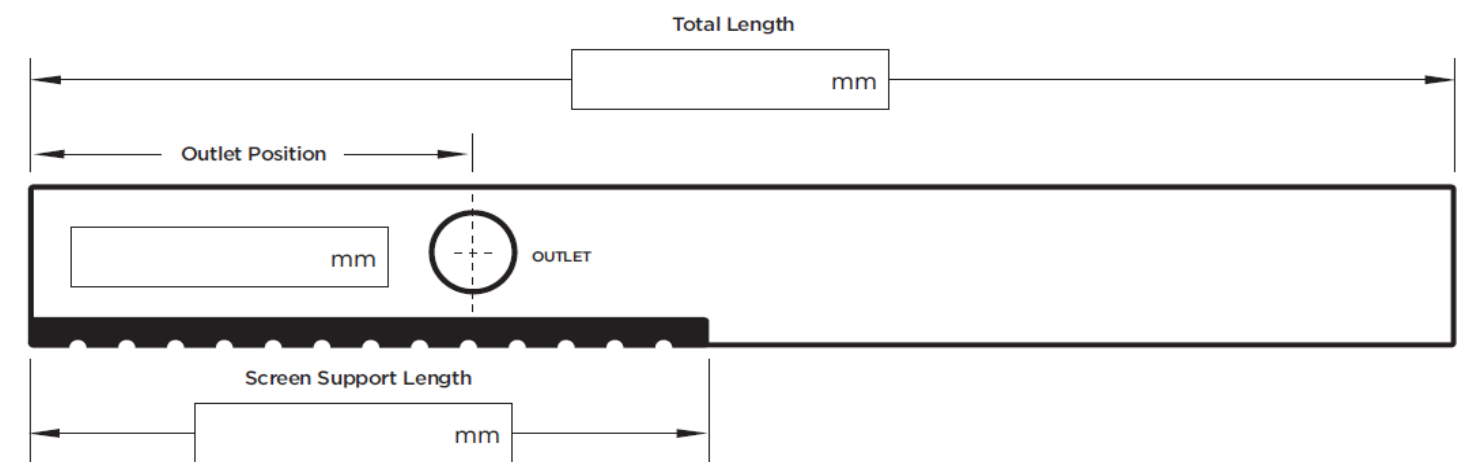

Label _____

Required Outlet Size

 76mm* 89mm

* Only suitable with DN80 riser

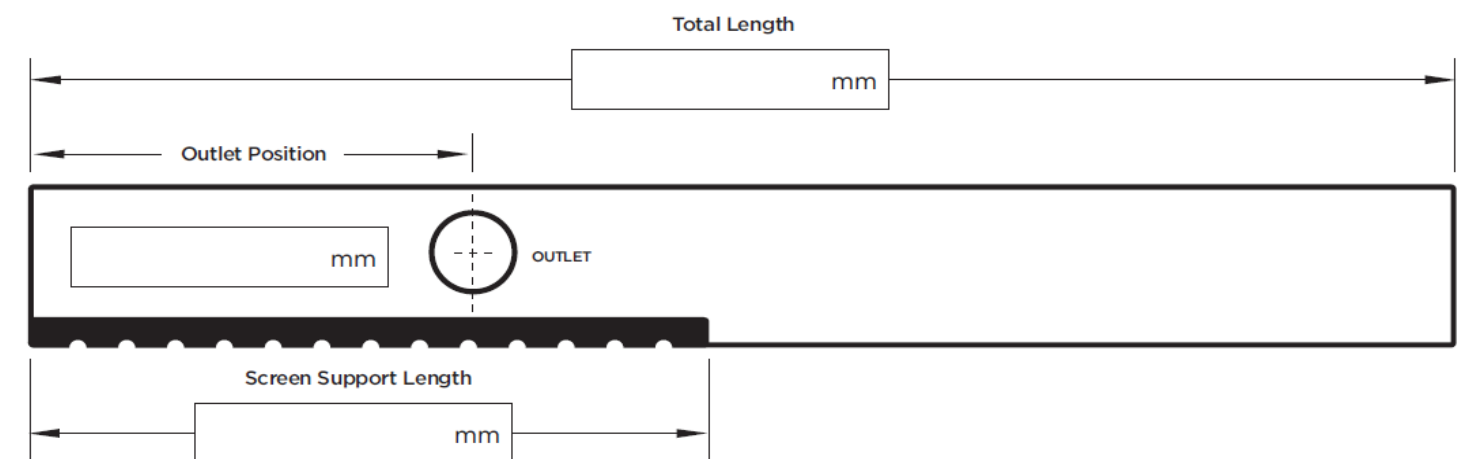

120SCSTiiMTL Right Hand Side Support

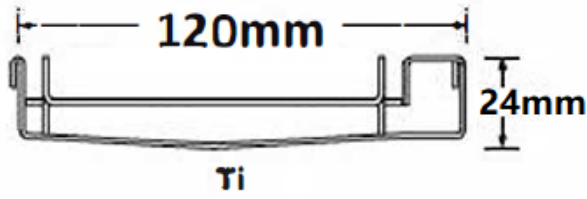

Full Name

Company Name

Project Name / Project Stage



Label _____

Required Outlet Size

 76mm* 89mm

* Only suitable with DN80 riser

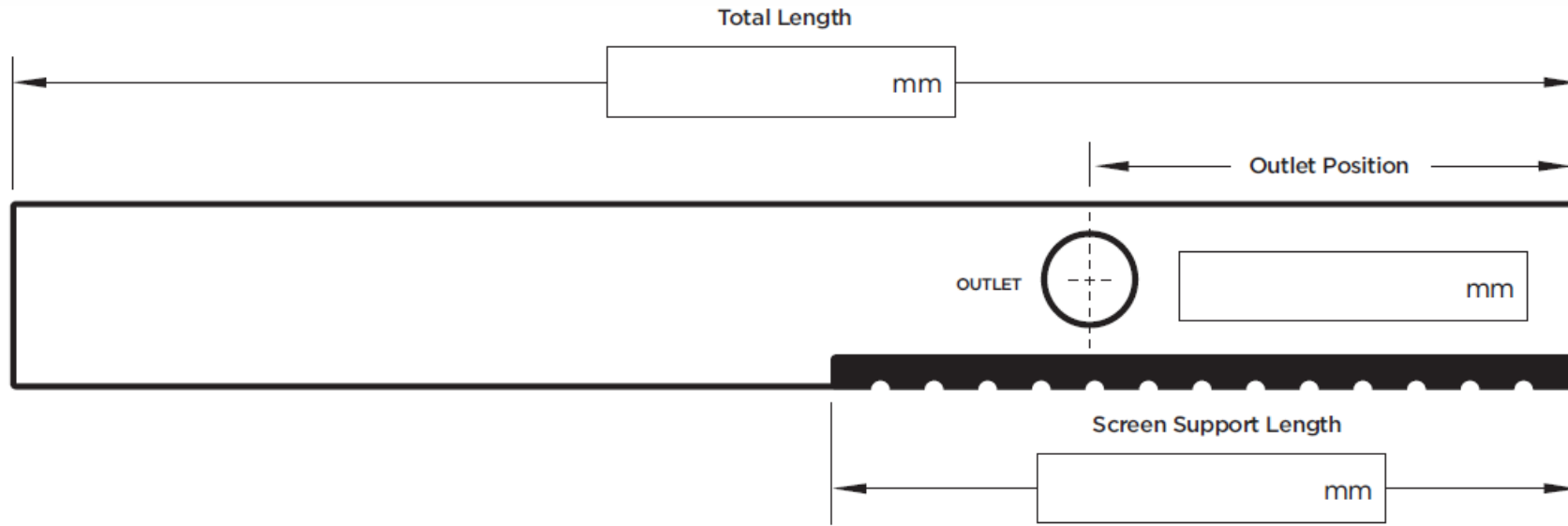

Label _____

Required Outlet Size

 76mm* 89mm

* Only suitable with DN80 riser

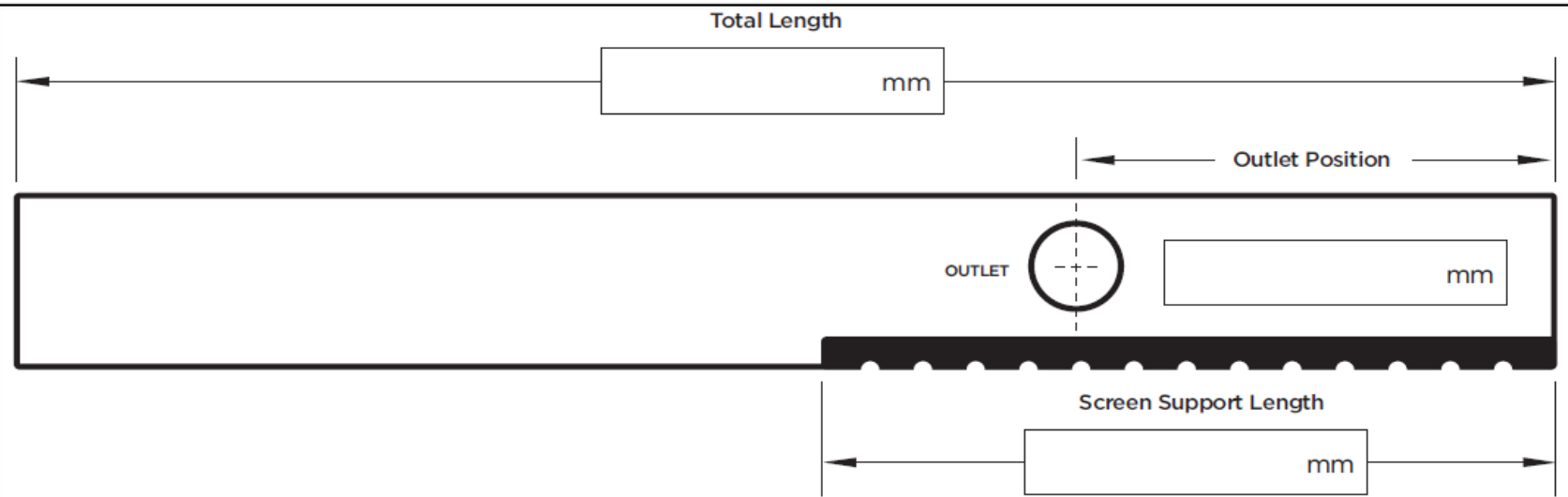

Label _____

Required Outlet Size

 76mm* 89mm

* Only suitable with DN80 riser

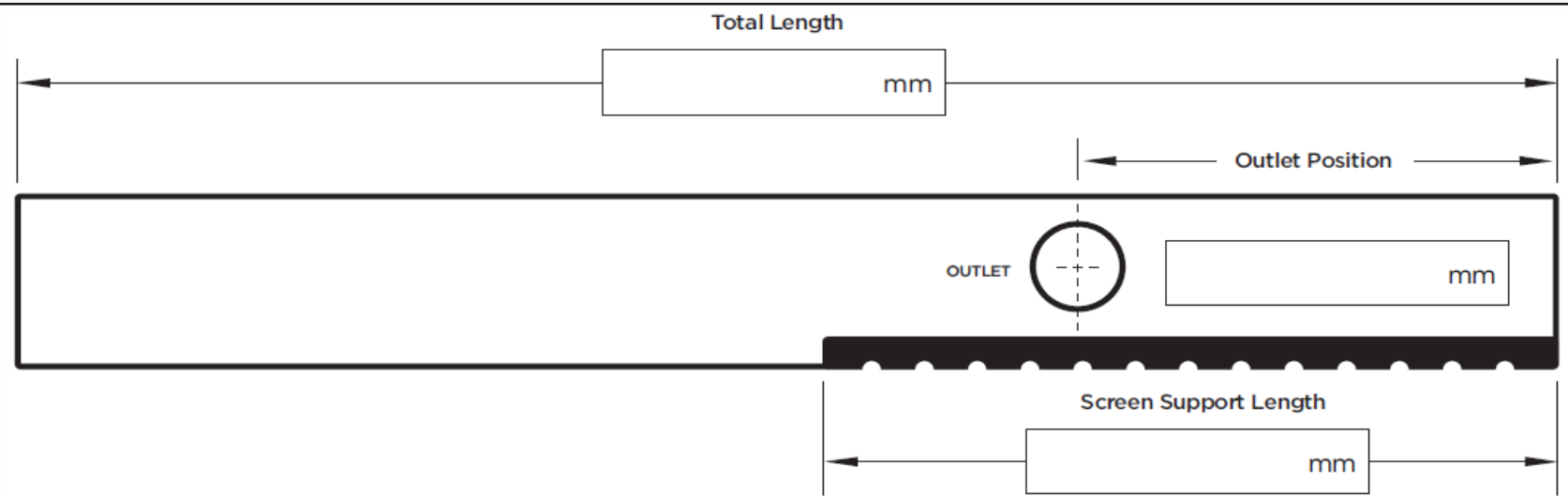

Label _____

Required Outlet Size

 76mm* 89mm

* Only suitable with DN80 riser

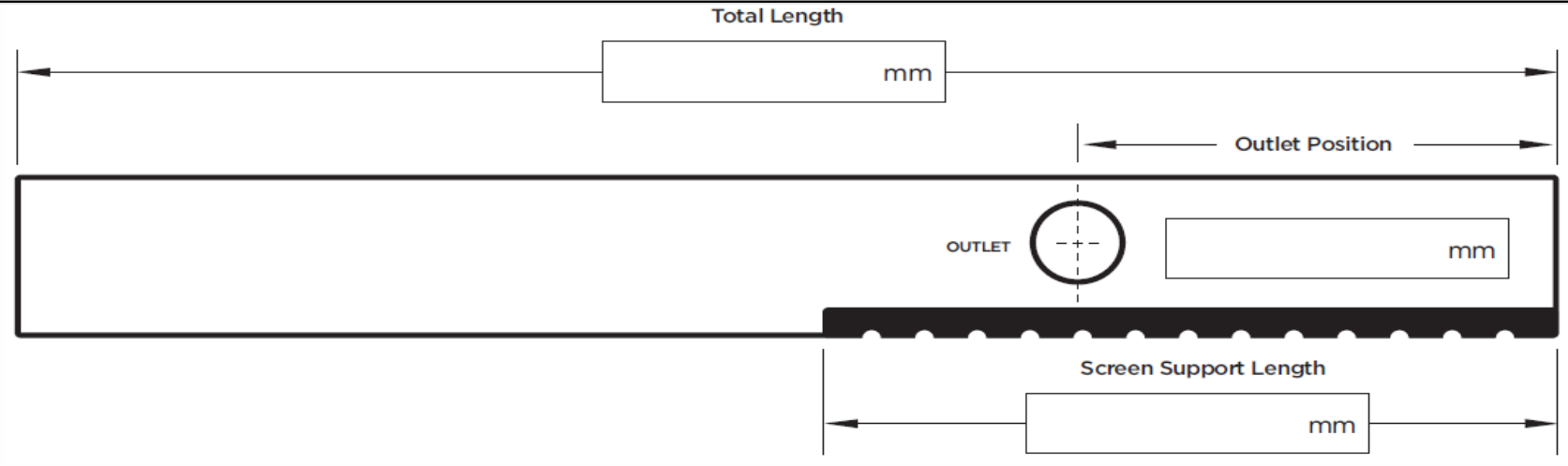

Label _____

Required Outlet Size

 76mm* 89mm

* Only suitable with DN80 riser

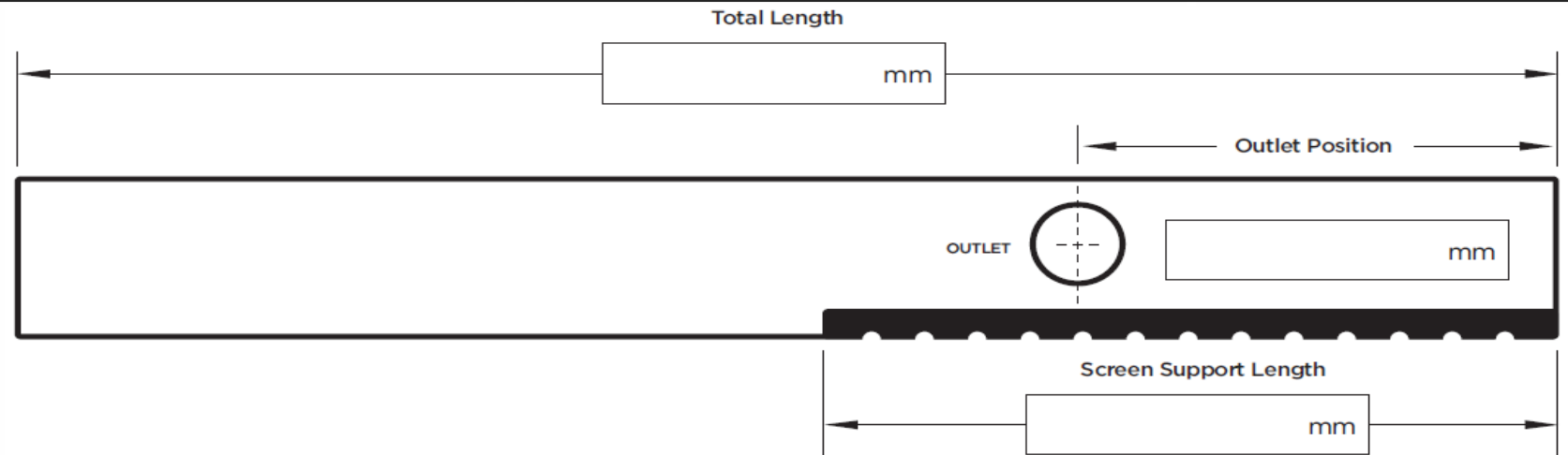

120SCSTiiMTL Dual-Sided Shower Screen Support

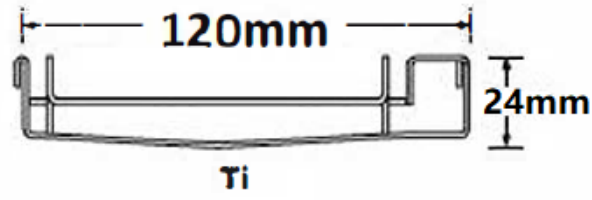

Full Name

Company Name

Project Name / Project Stage

MR-F-8.S.1-R2



Label _____

Required Outlet Size

76mm* 89mm

* Only suitable with DN80 riser

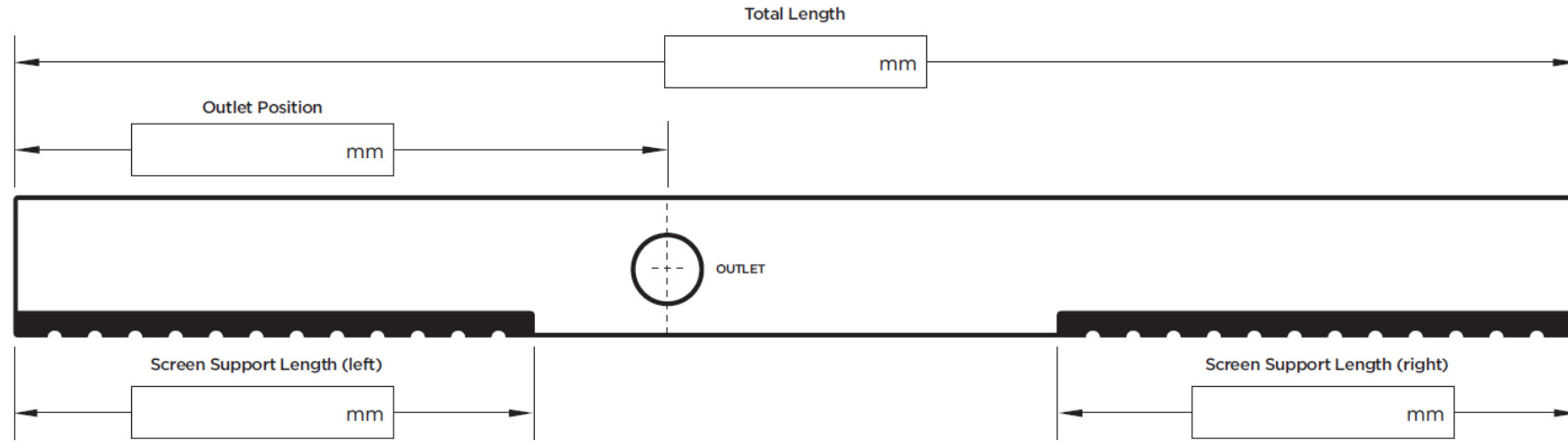

Label _____

Required Outlet Size

76mm* 89mm

* Only suitable with DN80 riser

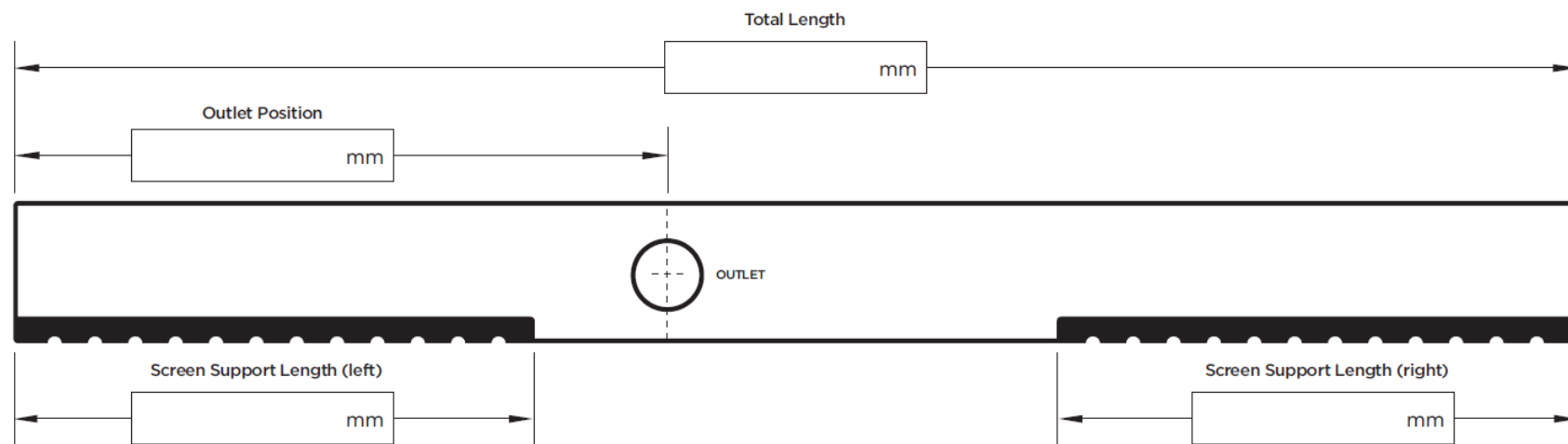

Label _____

Required Outlet Size

76mm* 89mm

* Only suitable with DN80 riser

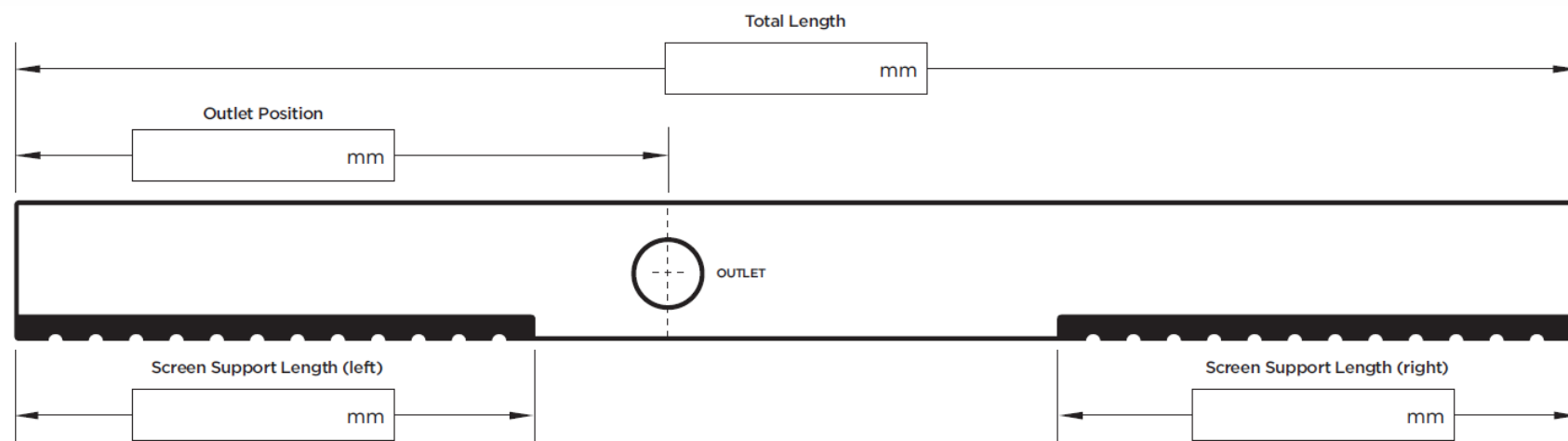

Label _____

Required Outlet Size

76mm* 89mm

* Only suitable with DN80 riser

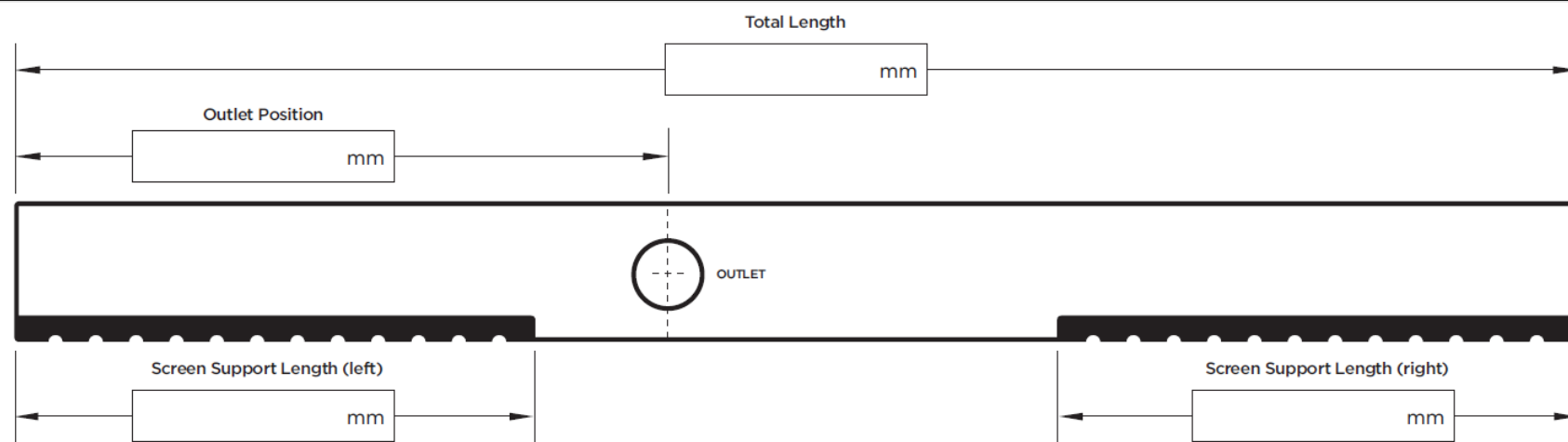

Label _____

Required Outlet Size

76mm* 89mm

* Only suitable with DN80 riser

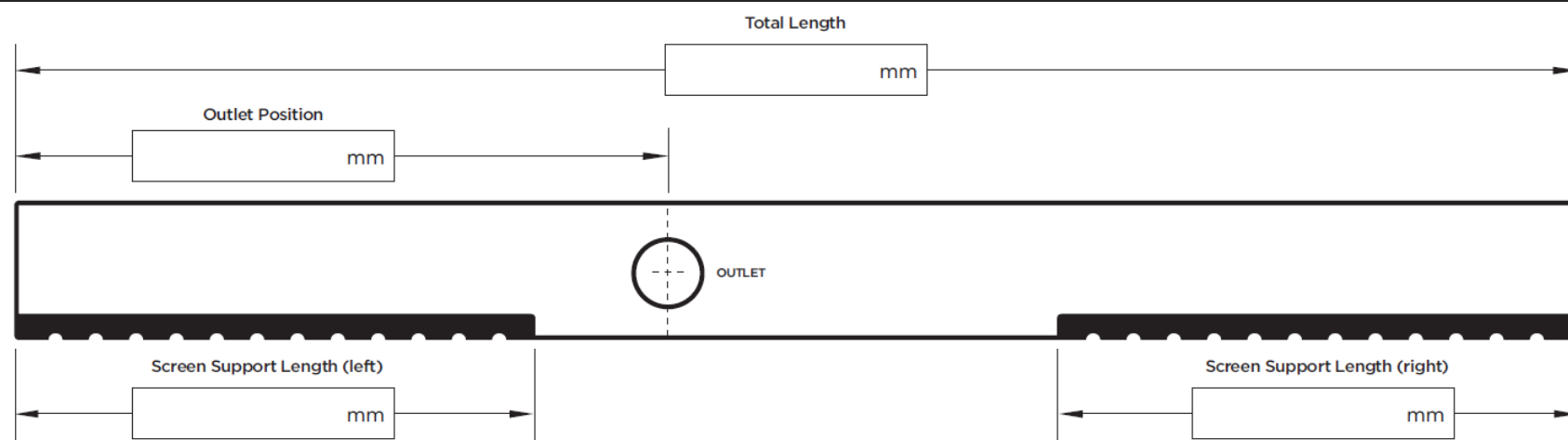

Visit slimlinedrain.co.uk

